

User Manual

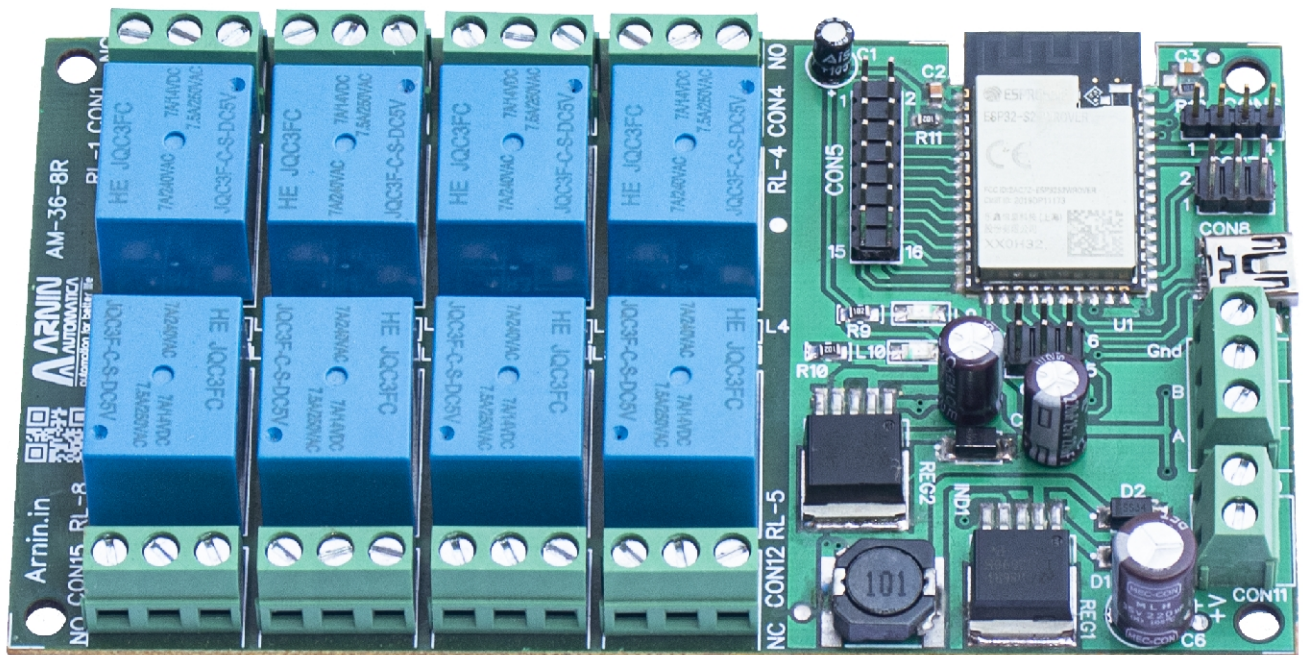

8 channel WiFi Relay & DAQ Board : AM-36-8R

Welcome to the User Manual for the AM-36-8R WiFi Relay Board, brought to you by Arnin Automatica Pvt. Ltd. We are headquartered in Hubli, a vibrant city nestled in the heart of Karnataka, India. We are thrilled to introduce you to our innovative WiFi relay board, designed to provide seamless control and monitoring of your electrical and electronic devices.

Board Overview

The AM-36-8R WiFi Relay Board is a versatile device equipped with four onboard relays, each offering precise control over your connected devices. With four output pins, four input pins, four analog-to-digital converter (ADC) pins, and four pulse-width modulation (PWM) pins, this board empowers you to manage a wide array of applications, from lighting and heating systems to sensors and actuators.

Effortless Control

Our WiFi relay board is designed for simplicity and convenience. Initial setup is a breeze with our user-friendly WiFi manager. Once connected to your local network, you can effortlessly control and monitor your devices using a web server accessible from any internet-enabled device, whether it's a computer or a smartphone.

Real-Time Updates

One of the standout features of the AM-36-8R is its real-time monitoring capability. You can monitor and control your devices in real-time, ensuring you stay in the loop with the latest status and changes, no matter where you are.

Versatile Applications

Whether you're a home automation enthusiast, an industrial professional, or an electronics hobbyist, this relay board is your trusted partner. It enables you to control and monitor numerous sensors, allowing you to create intelligent and responsive systems that cater to your unique needs.

In this user manual, we will provide you with comprehensive guidance on setting up, configuring, and making the most of your AM-36-8R WiFi Relay Board. We'll cover safety instructions, installation procedures, operational details, troubleshooting, and more. If you have any questions or require further assistance, our dedicated support team is always ready to help.

Thank you for choosing Arnin Automatica Pvt. Ltd. as your technology partner. Let's embark on a journey of efficient, smart, and connected control together with the AM-36-8R WiFi Relay Board.

Safety Instructions

Your safety is our top priority when using the AM-36-8R WiFi Relay Board. Please read and adhere to the following safety guidelines to ensure a secure and trouble-free experience.

1. Electrical Hazards:

Caution: This relay board deals with electrical circuits that may carry both AC and DC voltages.

Exercise extreme caution when working with live circuits.

Always disconnect power sources before installing or servicing the board.

Ensure that all connections are made correctly and securely to prevent electrical shocks or short circuits.

2. Mounting and Installation:

Mount the board in a suitable location that complies with local electrical and safety regulations.

Avoid mounting the board near heat sources, flammable materials, or in damp environments to prevent damage or fire hazards.

3. Overloading Relays:

Do not exceed the rated current and voltage specifications of the relays. Overloading relays can cause overheating and damage.

Use appropriate fuses or circuit protection devices to safeguard your circuits and equipment.

4. Wiring Precautions:

Insulate and protect exposed wires to prevent accidental contact or short circuits.

Use wire connectors and terminals that are suitable for the wire gauge and application.

Ensure proper grounding where required.

5. Compatibility and Voltage:

Verify that the voltage levels and signal levels of the devices you intend to connect are compatible with the relay board. Misuse or incorrect connections may lead to equipment damage or malfunction.

6. Regular Inspection:

Periodically inspect the relay board and its connections for signs of wear, damage, or loose connections. Replace any damaged components promptly.

7. High Temperatures:

The relay board may generate heat during operation. Allow adequate ventilation to dissipate heat and prevent overheating.

8. WiFi Network Security:

Secure your WiFi network with a strong password and encryption to prevent unauthorized access to the relay board.

9. Emergency Shutdown:

In case of emergencies or malfunctions, have a clear plan for shutting down power to the board and connected devices.

10. Contact Support:

If you encounter any issues or have questions about the relay board's operation or safety, do not hesitate to contact our customer support team.

By adhering to these safety instructions, you can maximize the safe and effective use of your AM-36-8R WiFi Relay Board while minimizing the risk of accidents, damage, or malfunctions.

Board Overview

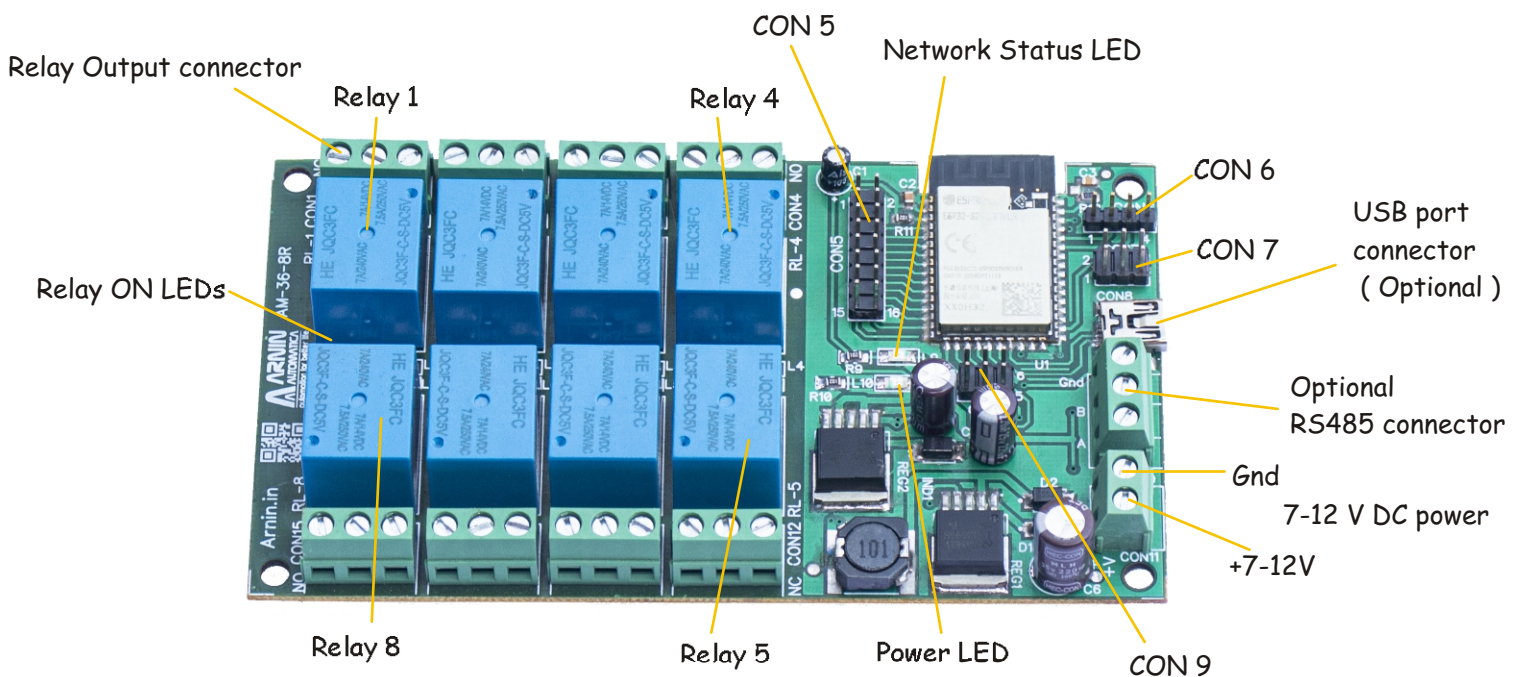

Technical Specifications -

No. Of Relays	- 8.
No. Of digital input/outputs	- up to 24 (depending upon models.)
Digital outputs sink/source current	- 5 mA max. (current beyond this limit may damage the board)
No. Of Analog inputs	- 18 (depending upon models.).
ADC resolution	- 13 bits , 8192 counts.
ADC input range	- 0 to 3.3 V Dc.
Relay Specifications	- Coil Voltage 5V Dc. Contact capacity - 5A Max.
Supply voltage	- 7 to 12 V Dc.
Supply Current	- 200 mA max.

Channel Connector details -

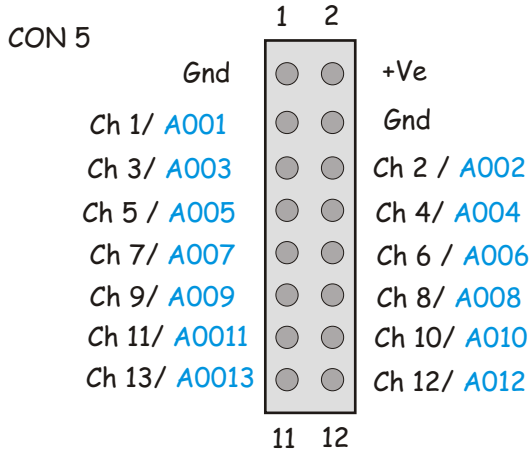

Channel Connector detail for this model

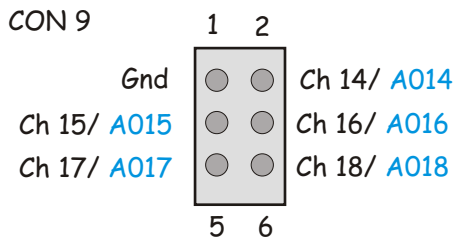
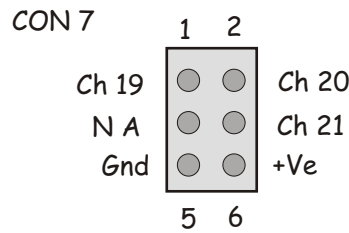
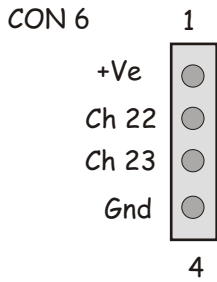
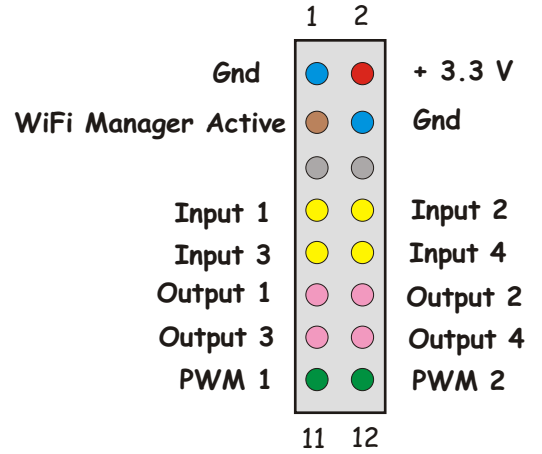

A001 to A018 - ADC channels

Ch 24 - User LED

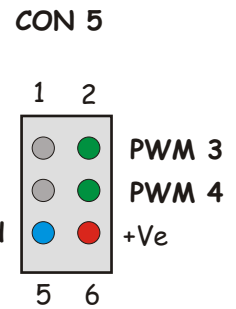

CON 7

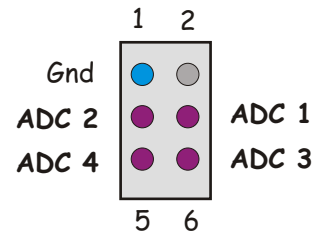

CON 9

- Gnd ○ Inactive
- + Ve ○ Do not connect

Configuration and Setup

Congratulations on acquiring your AM-36-8R WiFi Relay Board by Arnin Automatica Pvt. Ltd.

To ensure a smooth setup process and to begin harnessing the power of this versatile device, follow the steps below:

1. Gather Network Information:

When you receive the board for the first time, make sure you have your WiFi network's SSID (Network Name) and password readily available.

2. Enable WiFi Manager:

Locate Pin No. 1 and Pin No. 3 on CON 5, on the board and connect them using a jumper. This step activates the Arnin WiFi Manager.

3. Power On the Board:

Connect a 7-12 V DC power source to the designated power connector. Ensure that the positive (+Ve) power connects to the positive input connector and the negative (-Ve) to the negative input connector.

4. Indication LEDs:

The Power LED will illuminate, indicating that the board is powered.
The Network LED will blink rapidly, signaling that the WiFi Manager is initializing.

5. Connect to WiFi Manager:

On your PC or smartphone, access the Network settings.
In the list of available WiFi networks, locate "Arnin AM-36-8R WiFi Manager" and connect to it.

6. Access WiFi Manager Page:

Open a web browser and navigate to <http://192.168.4.1>.

7. Configure WiFi Settings:

You will be directed to the WiFi Manager web page.
Enter your WiFi network's SSID and password.
Provide a brief board name for identification.
Once all three fields are filled, click the "Submit" button.

8. Connection Confirmation:

The board will attempt to connect to your network.

Upon successful connection, it will display a message showing the IP address assigned by your router. Note that you don't need to memorize this IP address; you can also access the board via <http://yourboardname.local> (all lower case). Also note down the IP address.

9. Exit Setup Mode:

Power off the board.

Disconnect the jumper between Pin No. 1 and Pin No. 3 of CON 5. This action exits the setup mode.

10. Reconnect and Connect to Network:

- Power up the board again.
- The Network LED will blink once per second as it attempts to connect to your network.
- Once successfully connected, the LED will remain permanently on.

11. Access Control Dashboard:

- You can now access the control dashboard by visiting the IP address provided during the setup or <http://yourboardname.local>.
- Ensure that your PC or smartphone is connected to the same network.

12. Automatic Network Connection:

- From this point forward, the board will automatically connect to your network whenever it is powered up.
- Note that if there is no network available or if the board fails to connect to the previously programmed network in 10 seconds, it will enter setting mode automatically.
- You can identify this condition by observing the Network Status LED. A permanently ON LED indicates a successful connection, while a fast-blinking LED indicates a setting mode.

Your AM-36-8R WiFi Relay Board is now set up and ready for use. Enjoy seamless control and monitoring of your devices through the Control Dashboard, where you can manage inputs, outputs, relays, and PWM pins with ease.

8 Channel WiFi Relay & DAQ Board: AM-36-8R

User manual

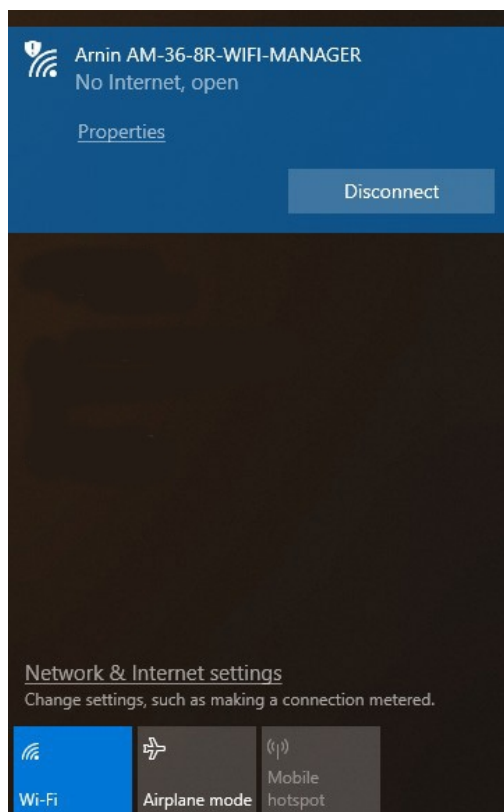
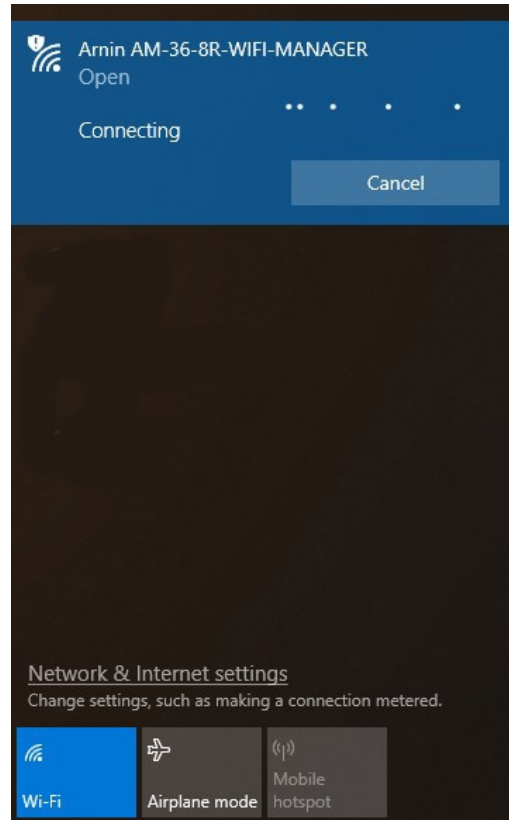
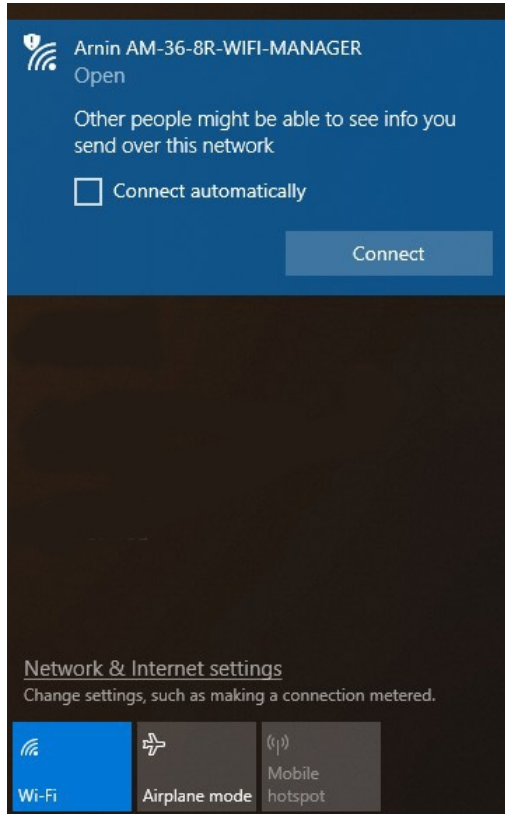

Connect to Arnin WiFi Manager first to set up the board as depicted here.

Once connected the web page at <http://192.168.4.1> will be as follow. Enter your credentials.

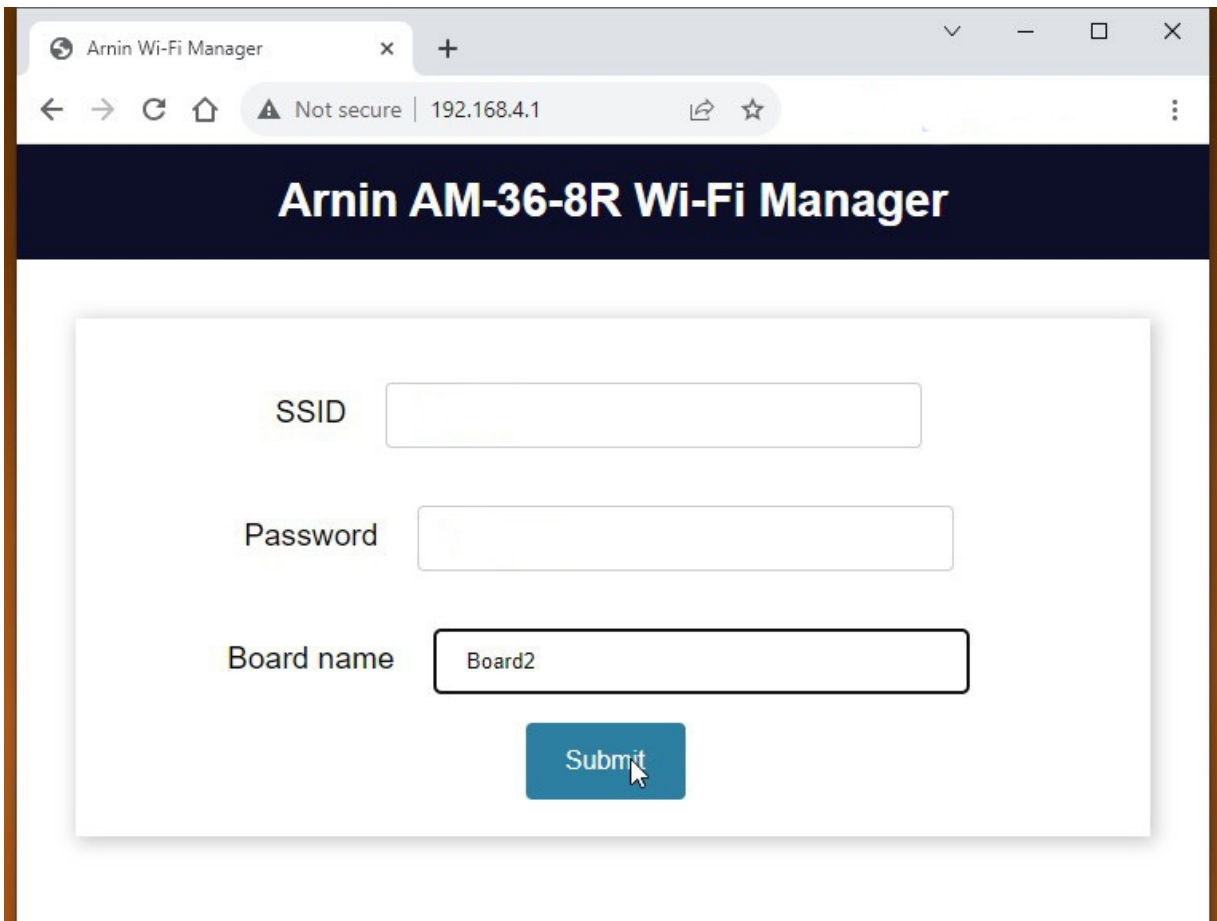

Once done, the board will connect to your router and provide IP provided by your router.

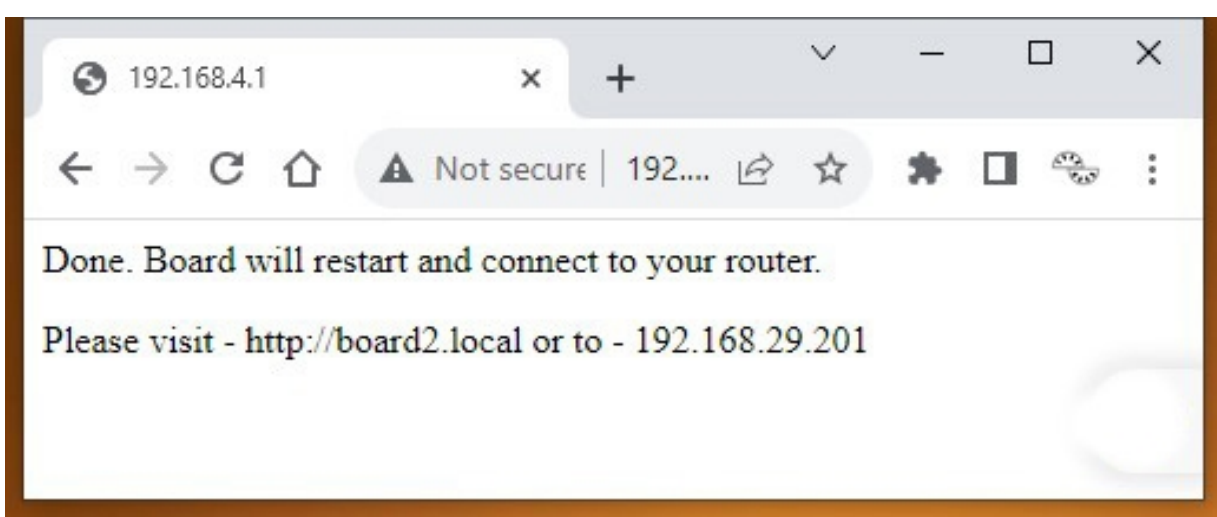

Some of the screen shots of Arnin AM-36-8R Dashboard on PC.

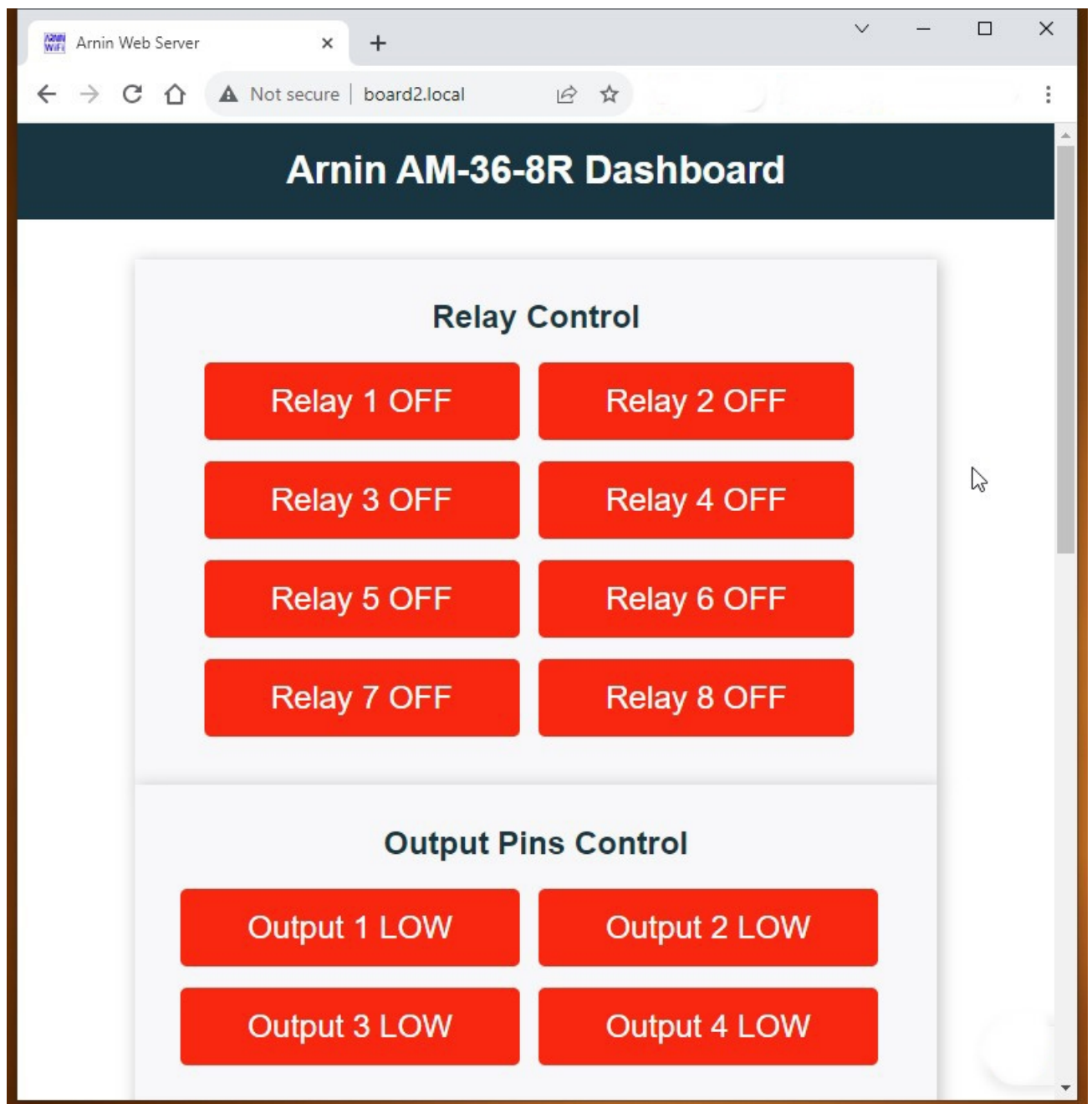

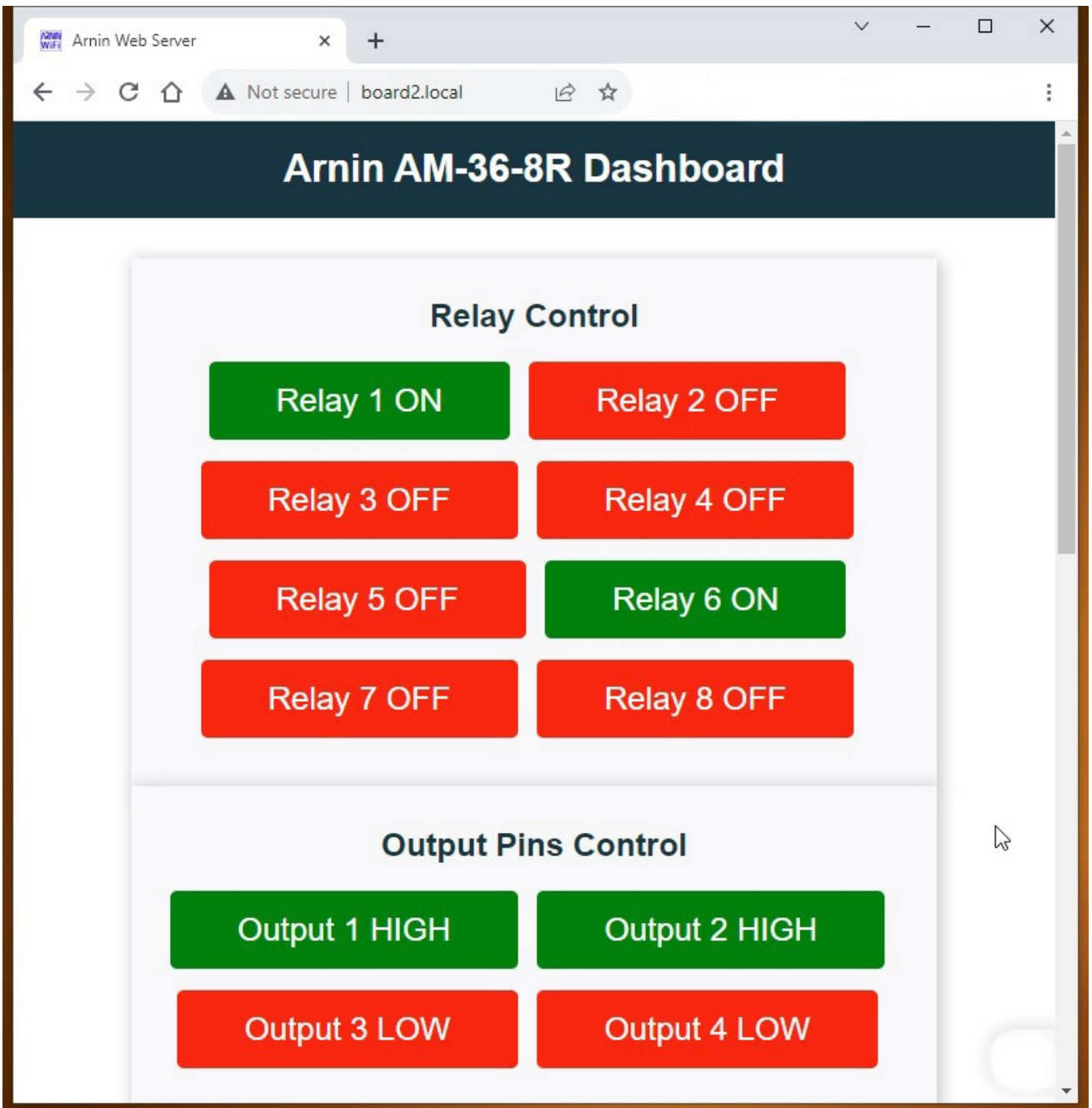

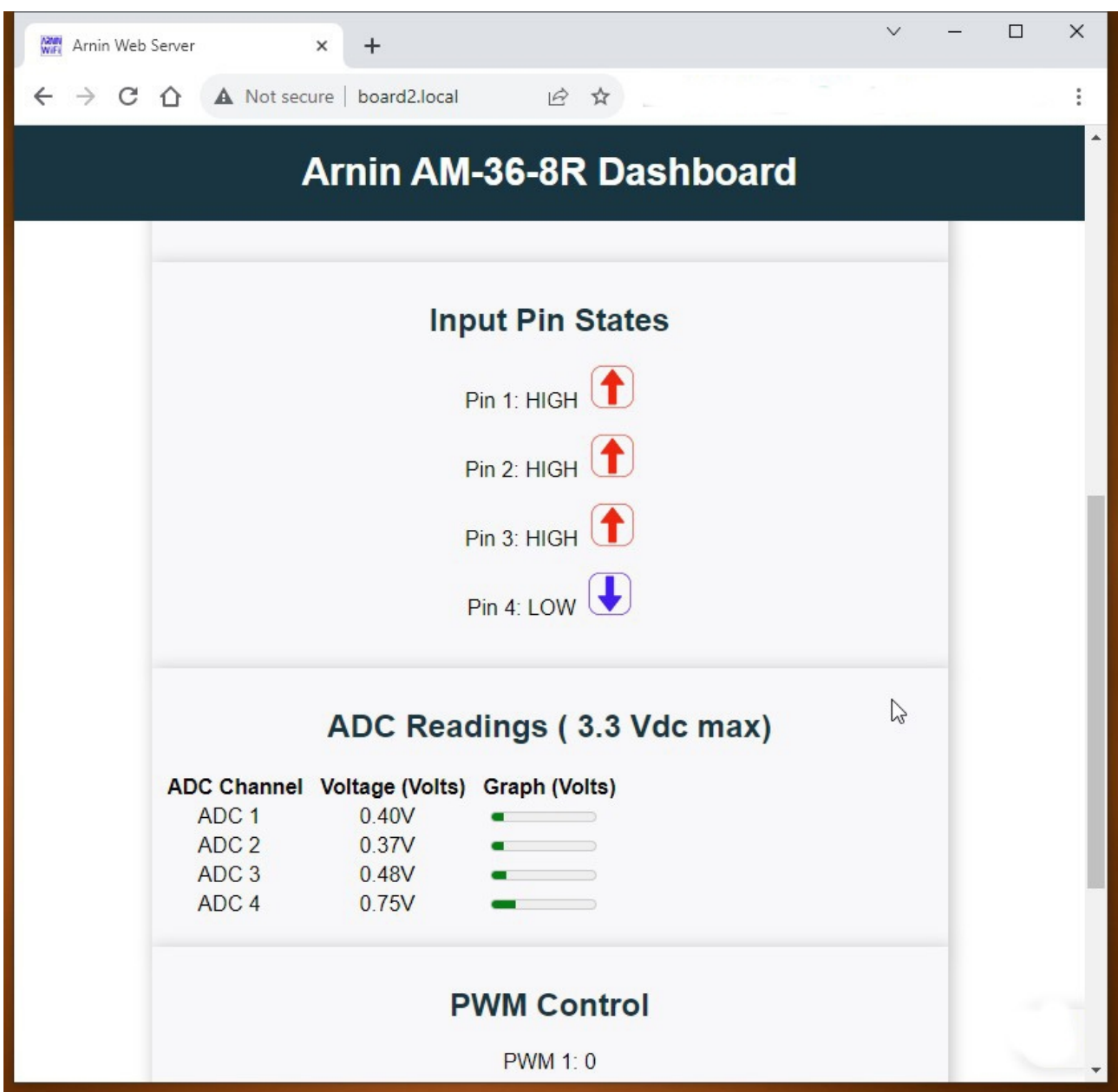

The screenshot shows a web browser window with the following content:

- Browser tab: Arnin Web Server
- Address bar: Not secure | board2.local
- Page Title: Arnin AM-36-8R Dashboard
- Section: ADC Readings (Volts)
- Table of ADC Readings:

ADC Channel	Voltage (Volts)	Graph (Volts)
ADC 1	0.41V	
ADC 2	0.37V	
ADC 3	0.48V	
ADC 4	0.73V	

- Section: PWM Control
- Four PWM sliders, each set to 0:

- PWM 1: 0
- PWM 2: 0
- PWM 3: 0
- PWM 4: 0

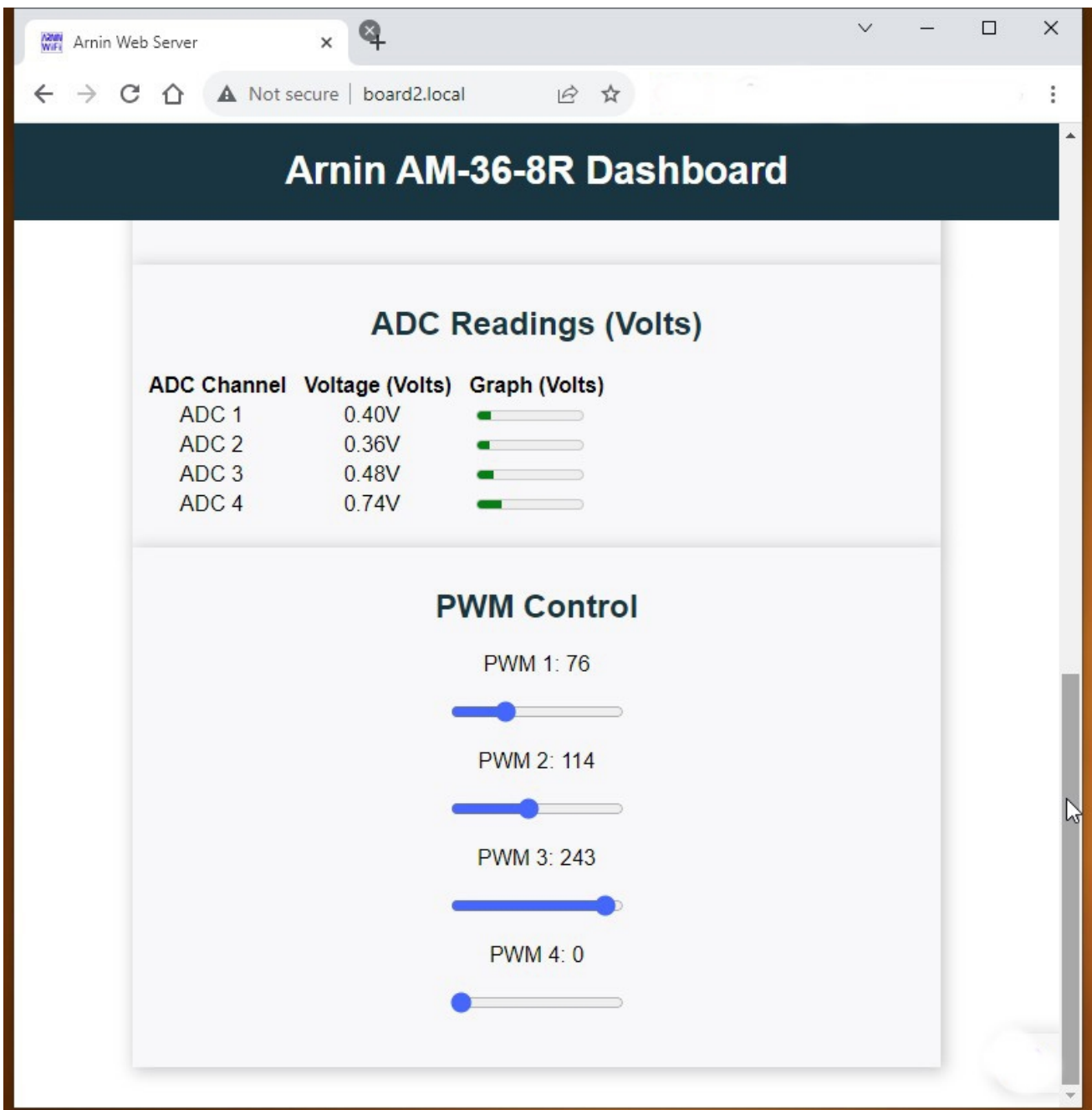

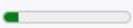
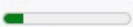
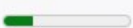

The screenshot shows a web browser window displaying the 'Arnin AM-36-8R Dashboard'. The browser's address bar shows 'board2.local' and the page title is 'Arnin AM-36-8R Dashboard'. The dashboard is divided into two main sections: 'ADC Readings (Volts)' and 'PWM Control'.

ADC Readings (Volts)

ADC Channel	Voltage (Volts)	Graph (Volts)
ADC 1	0.40V	
ADC 2	0.36V	
ADC 3	0.48V	
ADC 4	0.74V	

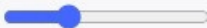
PWM Control

PWM 1: 76 

PWM 2: 114 

PWM 3: 243 

PWM 4: 0 

Some of the screen shots of Arnin AM-36-8R on Smartphone

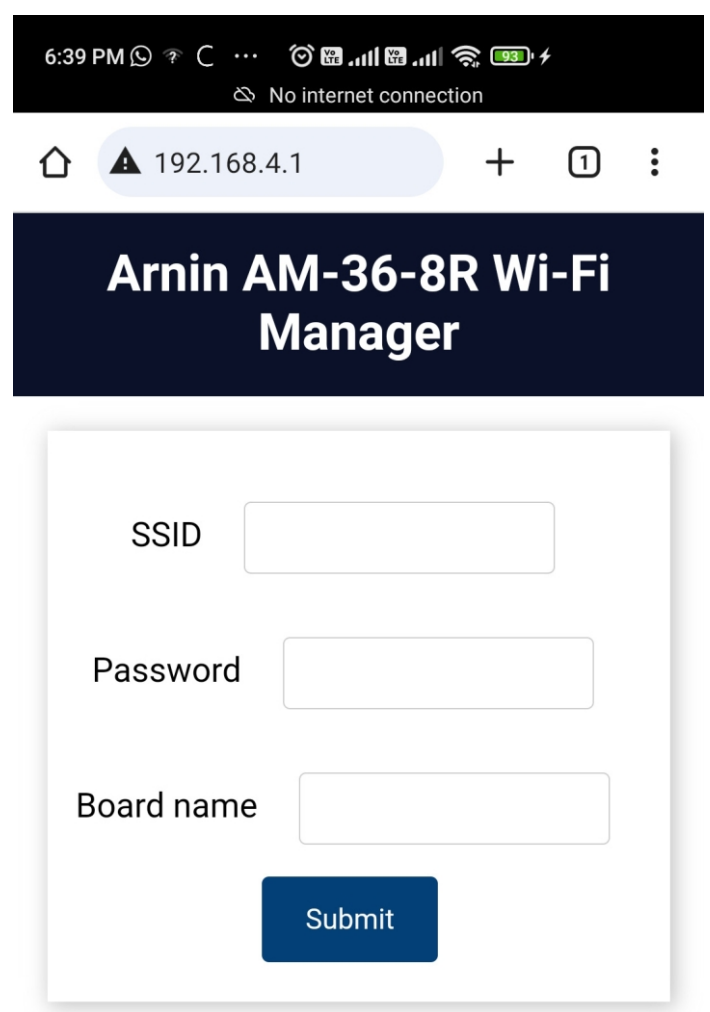
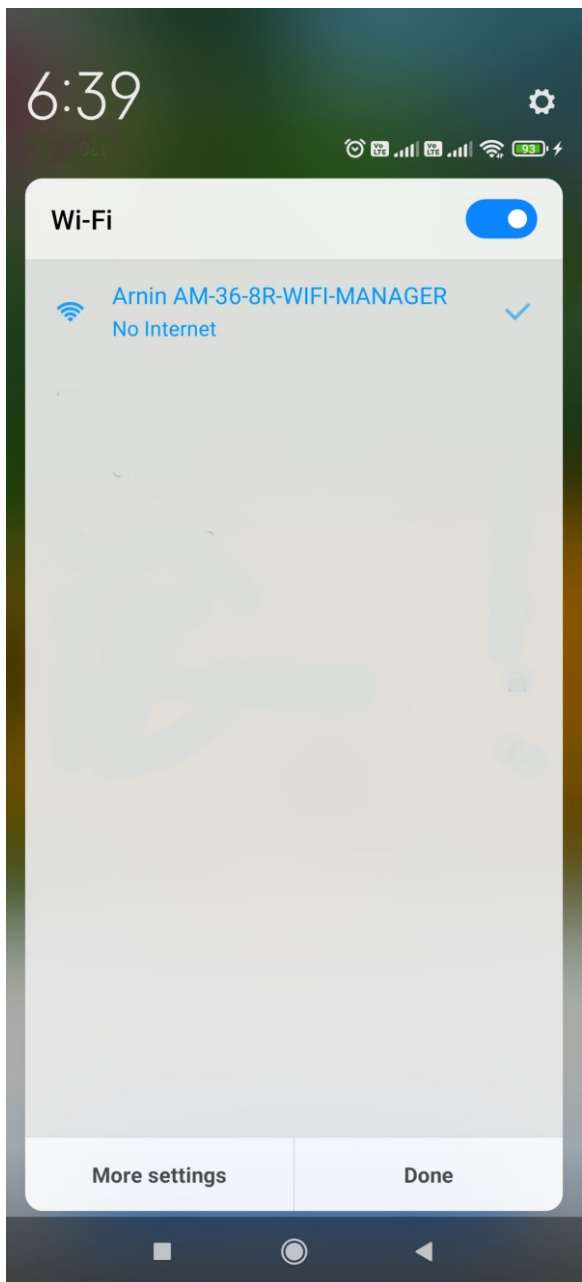

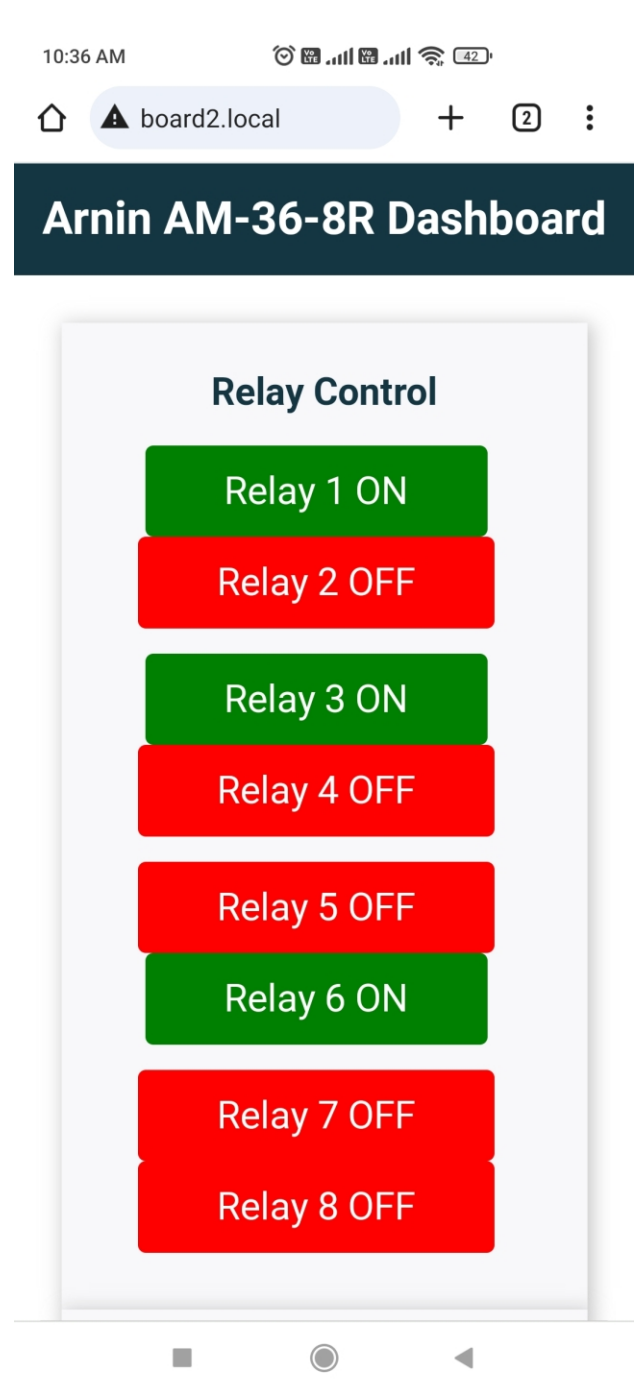
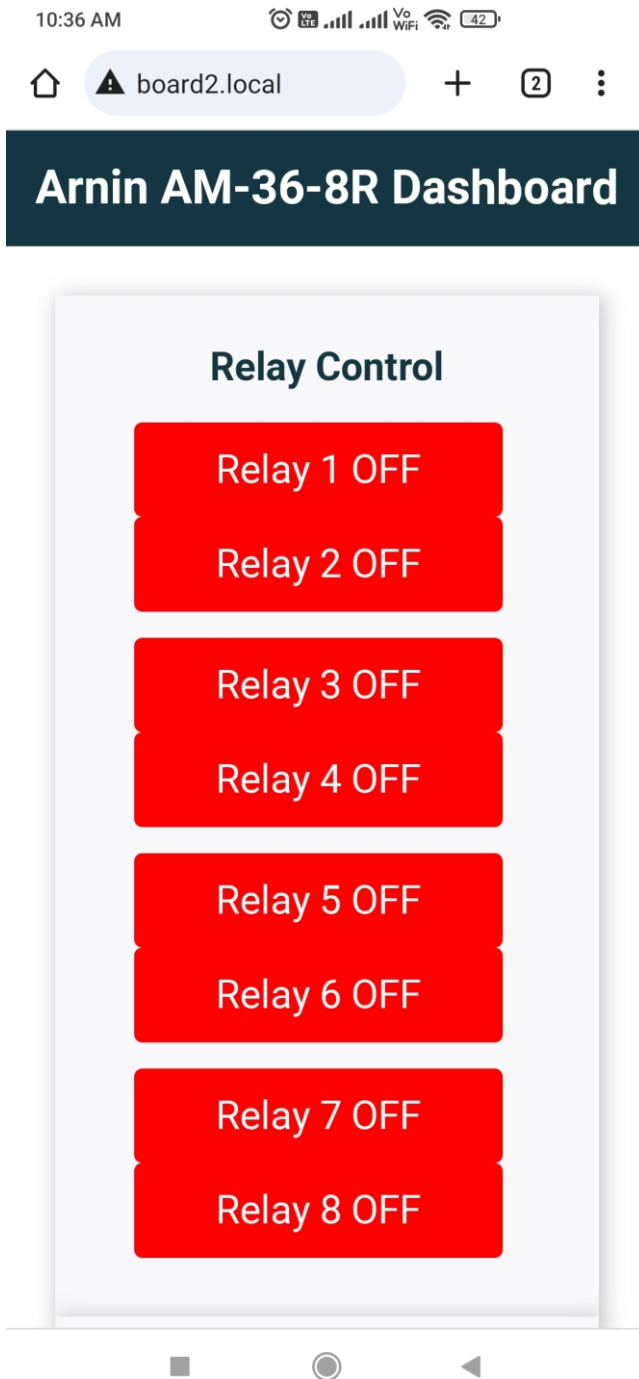

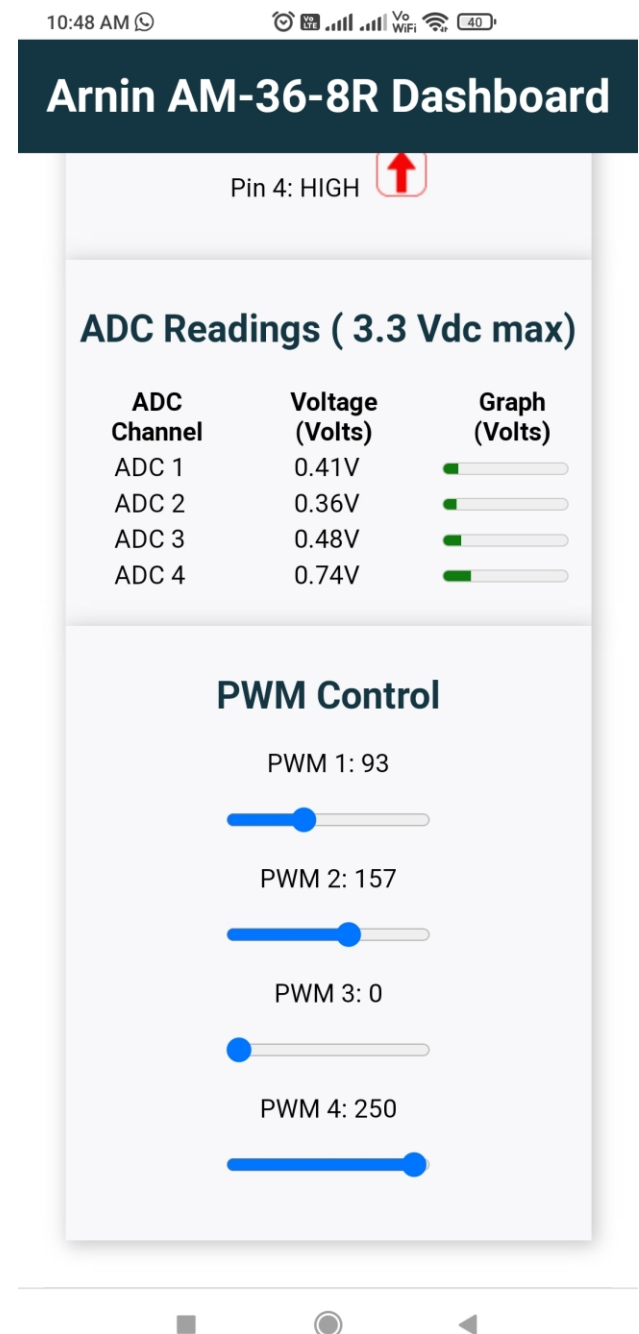
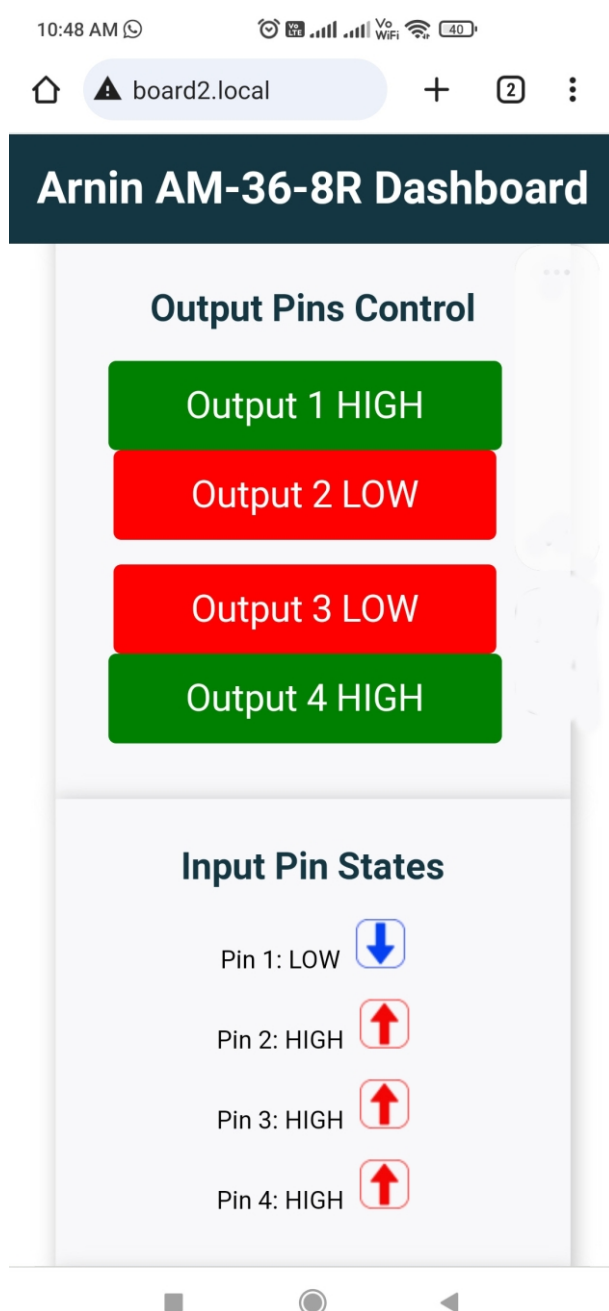

Troubleshooting:

1. No Power Indication:

Issue: The Power LED is not lit.

Solution:

Verify that the power source is correctly connected to the board.

Ensure the power supply voltage is within the recommended range (7-12 V DC).

Check for loose connections or damaged power cables.

2. WiFi Manager Not Accessible:

Issue: Unable to access the WiFi Manager web page.

Solution:

Confirm that the jumper connecting Pin No. 1 and Pin No. 3 of CON 5 is in place during setup.

Double-check that you are connected to "Arnin AM-36-8R WiFi Manager" in your device's WiFi settings.

Ensure that the correct IP address (<http://192.168.4.1>) is entered in your web browser.

3. Connection Failure to WiFi Network:

Issue: The board fails to connect to your WiFi network.

Solution:

Review and re-enter your WiFi network's SSID and password in the WiFi Manager.

Check your WiFi router's settings and confirm that it allows connections from your board.

Ensure your WiFi network is operational and within range.

4. IP Address Issues:

Issue: Unable to locate the board's IP address.

Solution:

Reboot the board to refresh the IP assignment from your router.

Use the alternative address <http://yourboardname.local> to access the board.

Consult your router's settings to identify connected devices and their assigned IP addresses.

5. Network Status LED Blinking Fast:

Issue: The Network Status LED is blinking rapidly.

Solution:

This indicates the board is in setting mode. Ensure you have completed the initial setup and that your network credentials are correct. If you have already configured the board, you can ignore this status.

6. Unresponsive Relay or Pins:

Issue: Relays, input pins, or PWM pins are unresponsive.

Solution:

Double-check your wiring to ensure proper connections.

Ensure that the board's firmware is up-to-date.

Test the control dashboard from a different device or browser.

Inspect connected devices for faults or malfunctions.

7. Poor Network Signal:

Issue: Weak WiFi signal in the area where the board is installed.

Solution:

Relocate the board to a position with better WiFi coverage.

Consider using WiFi range extenders or access points to improve signal strength in the board's vicinity.

8. Lost board Credentials:

Issue: You have forgotten IP or name of your board .

Solution:

Manually reset the board to its default settings and reconfigure it from scratch.

9. Firmware Errors:

Issue: Encountering firmware-related errors.

Solution:

Contact Arnin Automatica Pvt. Ltd. support for guidance or firmware updates.

10. Network Changes:

- Issue: Changing your WiFi network name or password.

- Solution:

- Update the board's WiFi settings in the control dashboard to reflect the new network information.

- If the board is unable to connect to the network, repeat the setup procedure.

If you encounter any issues not covered in this troubleshooting guide, or if problems persist despite following the provided solutions, please contact our dedicated customer support team at support@arnin.in for further assistance.

Warranty and Support

1. Limited Warranty:

Arnin Automatica Pvt. Ltd. stands behind the quality and performance of the AM-36-8R WiFi Relay Board. We offer a limited warranty for a specified period from the date of purchase. Please consult the warranty card or documentation provided with your product for the exact terms and duration of the warranty.

2. Warranty Coverage:

The warranty covers defects in materials and workmanship under normal use and conditions. It ensures that the product will be free from defects in material and workmanship during the specified warranty period.

3. Exclusions from Warranty:

The warranty does not cover damage or malfunctions resulting from misuse, neglect, accident, modification, improper installation, unauthorized repairs, or any alteration to the product without explicit authorization from Arnin Automatica Pvt. Ltd. Consumable components such as fuses are not covered by the warranty.

4. Contacting Customer Support:

For assistance, questions, or warranty claims, please contact Arnin Automatica Pvt. Ltd. Customer Support through the following channels:

Phone: +91 7975740846

Email: support@arnin.in

Website: <https://arnin.in>

6. Technical Support:

Our technical support team is available to assist you with any product-related queries or issues. Feel free to reach out for guidance on installation, setup, troubleshooting, or usage.

7. Returns and Repairs:

If you need to return a product for warranty service or repair, please follow the return instructions provided by our customer support team. Ensure that the product is securely packaged to prevent damage during transit.

8. Proof of Purchase:

To claim warranty service, you may be required to provide a copy of your original sales receipt or proof of purchase. Please retain this document for your records.

10. Limitation of Liability:

- Arnin Automatica Pvt. Ltd. shall not be liable for any direct, indirect, incidental, special, consequential, or punitive damages, including but not limited to loss of data, loss of profit, or personal injury, arising from the use or inability to use the product.

11. Governing Law:

- Any disputes arising from the terms of this warranty shall be governed by the laws of Karnataka, India without regard to its conflict of law principles.

We are committed to ensuring your satisfaction with the AM-36-8R WiFi Relay Board. If you have any questions or concerns regarding the warranty or product support, please do not hesitate to get in touch with us. Your feedback is invaluable, and we look forward to assisting you.

Frequently Asked Questions (FAQs)

Q1: What is the AM-36-8R WiFi Relay Board used for?

A: The AM-36-8R WiFi Relay Board allows you to control and monitor various devices, such as lights, appliances, sensors, and more, using a web-based interface. It's ideal for home automation, industrial applications, and electronics projects.

Q2: How do I set up the WiFi Relay Board for the first time?

A: Refer to the "Setting Up Your AM-36-8R WiFi Relay Board" section in this manual for step-by-step instructions on the initial setup process.

Q3: Can I control the board from a smartphone?

A: Yes, you can control the board from a smartphone. Simply connect your smartphone to the same WiFi network as the board and access the control dashboard via a web browser.

Q4: Is it possible to control multiple devices simultaneously with this board?

A: Yes, the AM-36-8R WiFi Relay Board supports the control of multiple devices, making it suitable for managing various applications and sensors.

Q5: What should I do if I forget my WiFi network's SSID or password?

A: If you forget your WiFi network credentials, you may need to manually reset the board to its default settings and reconfigure it. Refer to the "Troubleshooting" section for guidance on resetting the board.

Q6: How can I update the firmware of the WiFi Relay Board?

A: Contact Arnin Automatica Pvt. Ltd. customer support for information on firmware updates and instructions on how to update the board's firmware.

Q7: What happens if the Network Status LED blinks rapidly?

A: A fast-blinking Network Status LED indicates that the board is in setting mode. If you have already completed the initial setup and no SSID or password changes are required, you can ignore this status.

Q8: Can I extend the warranty period for the WiFi Relay Board?

A: Arnin Automatica Pvt. Ltd. may offer options to extend the warranty period. Please contact our customer support team for more details.

Q9: How do I access the Control Dashboard after setup?

A: After setup, you can access the Control Dashboard by visiting the IP address provided during setup or by using `http://yourboardname.local` in your web browser. Ensure that your device is connected to the same network as the board.

Q10: What should I do if I encounter a technical issue not covered in this manual?

- A: If you face technical issues or have questions that are not addressed in this manual, please reach out to Arnin Automatica Pvt. Ltd. customer support for assistance.

Q11: Is there a mobile app available for controlling the WiFi Relay Board?

- A: Currently, the board is controlled via a web-based interface accessible from any web browser on a computer or smartphone. There may be future developments for mobile apps; please check our website for updates.

Q12: Is it possible to integrate this board with other smart home systems or platforms?

- A: Depending on the capabilities of the other systems or platforms, it may be possible to integrate the board. Consult the documentation or support resources of the specific system or platform you wish to connect with for guidance.

Q13: Can I use this board for remote monitoring and control over the internet?

- A: Yes, you can remotely monitor and control your devices using the Control Dashboard over the internet. Contact our support team for more information..

Q14: What is the range of the WiFi signal for this board?

- A: The WiFi range depends on various factors, including your WiFi router and environmental conditions. If you experience signal issues, consider using WiFi range extenders or access points to improve coverage.

Q15: How can I secure my WiFi network for use with the board?

- A: To enhance security, ensure your WiFi network is password-protected and uses encryption (e.g., WPA2 or WPA3). Keep your network password confidential to prevent unauthorized access.

For additional questions or inquiries, please contact our support team at support@arnin.in

Legal and Disclaimers

Copyright Notice:

The content of this user manual, including all text, diagrams, images, and other materials, is protected by copyright laws and is the intellectual property of Arnin Automatica Pvt. Ltd. Unauthorized reproduction, distribution, or use of this content is prohibited.

Trademark Notice:

The names, logos, and trademarks used in this manual to refer to Arnin Automatica Pvt. Ltd. and its products are the exclusive property of Arnin Automatica Pvt. Ltd. Any use of these trademarks without the express written consent of Arnin Automatica Pvt. Ltd. is strictly prohibited.

Limitation of Liability:

Arnin Automatica Pvt. Ltd. shall not be liable for any direct, indirect, incidental, special, consequential, or punitive damages, including but not limited to loss of data, loss of profit, or personal injury, arising from the use or inability to use the AM-36-8R WiFi Relay Board.

Product Alterations:

Any unauthorized modifications, alterations, or tampering with the AM-36-8R WiFi Relay Board, including the removal of serial numbers or labels, will void the warranty and may result in unsafe operation of the product.

Third-Party Components:

The AM-36-8R WiFi Relay Board may include components or software provided by third-party manufacturers or developers. Arnin Automatica Pvt. Ltd. does not assume responsibility for the performance, reliability, or security of these third-party components.

Compliance with Local Regulations:

Users are responsible for ensuring that the installation and use of the AM-36-8R WiFi Relay Board comply with all applicable local, regional, and national regulations, codes, and standards related to electrical equipment and wireless communication devices.

Software Updates:

Arnin Automatica Pvt. Ltd. may release firmware updates to enhance the functionality and security of the WiFi Relay Board. Users are encouraged to regularly check for and apply these updates through the official channels provided by Arnin Automatica Pvt. Ltd.

Technical Specifications:

While every effort has been made to ensure the accuracy of the technical specifications and information provided in this manual, Arnin Automatica Pvt. Ltd. reserves the right to make changes or improvements to the product without prior notice.

Indemnification:

Users of the AM-36-8R WiFi Relay Board agree to indemnify and hold Arnin Automatica Pvt. Ltd., its employees, and affiliates harmless from any claims, liabilities, or damages arising from their use of the product.

Governing Law:

Any legal disputes or claims related to the AM-36-8R WiFi Relay Board or its use shall be governed by the laws of India, and any legal proceedings shall be conducted in the courts of Hubli, Karnataka, India.

Privacy Statement:

Arnin Automatica Pvt. Ltd. values your privacy and is committed to protecting your personal information. Please refer to our Privacy Policy, available on our website, for details on how we collect, use, and safeguard your data.

Safety Disclaimer:

Users are responsible for following all safety instructions provided in this manual and exercising caution when working with electrical circuits and equipment. Arnin Automatica Pvt. Ltd. shall not be liable for any injuries or damages resulting from unsafe or improper use of the AM-36-8R WiFi Relay Board.

Contact Information:

For questions, concerns, or legal inquiries, please contact Arnin Automatica Pvt. Ltd. through the following channels:
Phone: +91 7975740846
Email: support@arnin.in
Website: <https://arnin.in>

Feedback and Contact Information

1. We Value Your Feedback:

Arnin Automatica Pvt. Ltd. greatly appreciates your feedback. We are dedicated to continuously improving our products and services based on your experiences and suggestions.

2. How to Provide Feedback:

Your feedback is important to us, and there are several ways to share your thoughts:

Customer Support: Contact our customer support team to provide feedback, report issues, or seek assistance.

Online Feedback Form: Visit our website and use our online feedback form to submit your comments, questions, or suggestions.

Email: You can send your feedback via email to info@arnin.in.

Social Media: Connect with us on social media platforms and share your thoughts on our products and services.

3. Product Improvement:

Your feedback helps us identify areas for improvement and innovation. Whether it's a feature request, a usability concern, or a technical issue, we welcome your input.

4. Technical Support:

If you require technical assistance with the AM-36-8R WiFi Relay Board, please do not hesitate to contact our technical support team.

5. Contact Information:

For any inquiries, assistance, or information related to the AM-36-8R WiFi Relay Board or Arnin Automatica Pvt. Ltd., you can reach us at:

Phone: + 91 7975740846

Email: info@arnin.in

Website: <https://arnin.in>

6. Stay Connected:

Keep up-to-date with the latest product announcements, news, and updates by following us on social media or visiting our website regularly.

7. Privacy of Contact Information:

We respect your privacy and will use your contact information only for the purpose of responding to your inquiries or feedback. For more details, please refer to our Privacy Policy.

8. Customer Satisfaction:

Your satisfaction is our priority, and we are committed to providing you with exceptional support and service. Your feedback helps us achieve this goal.

Thank You for Choosing Arnin Automatica Pvt. Ltd.:

We would like to express our gratitude for choosing the AM-36-8R WiFi Relay Board and for considering Arnin Automatica Pvt. Ltd. as your technology partner. We look forward to hearing from you and assisting you with your needs.

Where can our AM-36-8R WiFi Relay Board be used ?

Practical Applications and Use Cases

The AM-36-8R WiFi Relay Board is a versatile device designed to provide control and monitoring capabilities for various applications. Here are some possible uses of this WiFi relay board:

Home Automation:

Control and automate lighting, heating, and cooling systems in your home. Create schedules and remotely adjust settings for energy efficiency and convenience.

Smart Garden:

Automate irrigation systems, garden lighting, and fountain pumps based on weather conditions and specific watering schedules.

Security Systems:

Integrate the board into your home or office security system to control alarms, door locks, and surveillance cameras remotely.

Industrial Automation:

Monitor and control industrial machinery, conveyor belts, and production lines. Receive real-time status updates and alerts for efficient operation.

Greenhouse Management:

Create optimal growing conditions for plants by controlling temperature, humidity, and irrigation systems. Adjust settings remotely based on plant requirements.

Aquarium Control:

Manage aquarium lighting, filtration systems, and water pumps to maintain the health and well-being of aquatic life.

Remote Sensor Monitoring:

Connect various sensors, such as temperature, humidity, motion, and gas sensors, to the board to monitor environmental conditions and receive alerts.

Home Theater Control:

Automate audio and video components, screen/projector control, and lighting to enhance the home theater experience.

HVAC Systems:

Control heating, ventilation, and air conditioning (HVAC) systems to maintain optimal indoor comfort while saving energy.

Access Control:

Manage electronic locks and access control systems for secure entry to buildings or rooms. Grant and revoke access remotely.

Lighting Scenes:

Create custom lighting scenes for different occasions, such as movie night, romantic dinner, or party mode, and activate them with a single click.

Pump Control:

Control pumps for water supply, wastewater treatment, or swimming pool circulation to maintain water quality and efficiency.

Garage Door Opener:

Use the board to remotely open and close garage doors, providing convenience and security.

Feeder Control:

Automate pet and livestock feeders to ensure regular feeding schedules, even when you're not at home.

Energy Management:

Monitor energy consumption and control appliances to reduce energy costs and environmental impact.

Custom Projects:

Create DIY electronics projects by integrating the board into your custom applications, experiments, or prototypes.

Green Energy Systems:

Combine the board with renewable energy sources like solar panels and wind turbines for remote monitoring and control of power generation and distribution.

Lighting Art Installations:

Use the board to control dynamic lighting effects in art installations, sculptures, and interactive exhibits.

Remote Switching:

Turn devices on or off remotely, such as water heaters, pumps, or machinery, to save energy and extend equipment lifespan.

Event Automation:

Automate event lighting, sound, and other systems for weddings, parties, or corporate events, creating memorable experiences.

These are just a few examples of the many possibilities offered by the AM-36-8R WiFi Relay Board. Its flexibility, remote control capabilities, and support for various sensors make it a valuable tool for enhancing convenience, efficiency, and automation in both residential and industrial settings. We can help you to customize and adapt its functions to suit your specific needs and projects.

Using Relay Outputs -

Relay outputs can be used to operate various electrical devices under software control. **Extreme care should be taken if you are using 110 or 230 V AC. Arnin will not be responsible for any kind of damage or loss whatsoever to life or property. It will be totally user's responsibility.**



- NC - Normally closed contact - connected with common when relay is off. Disconnected while on.
- C - Common contact.
- NO- Normally open contact - connects with common when relay is on. Disconnected while off.

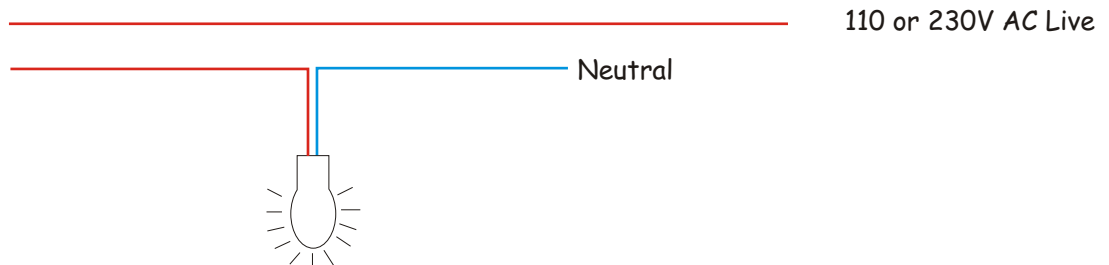

Use of RC Snubber Circuit across relay contacts is recommended to avoid electrical interference. It is must when Relays are used to operate any inductive load like motor, coil, relay, transformer etc. The value of R - can be from 39 ohms to 1 Kilo ohms & C may be from 0.01 mf to 0.1 mf 400V.

The R & C is connected in series & both ends are connected across two relay contacts -Common & NC. The purpose is to absorb back EMF generated when the load is disconnected from supply. When relay is made off the energy stored in inductive load try to jump across relay contacts which results in sparks. This sparks across contacts not only damage the tip material but also induce noise to the power supply circuit. This noise may cripple functioning of micro controller used in circuit. So if you use any inductive load with this circuit, do connect RC Snubber Circuit across the relay contacts

Board Dimensions in mm

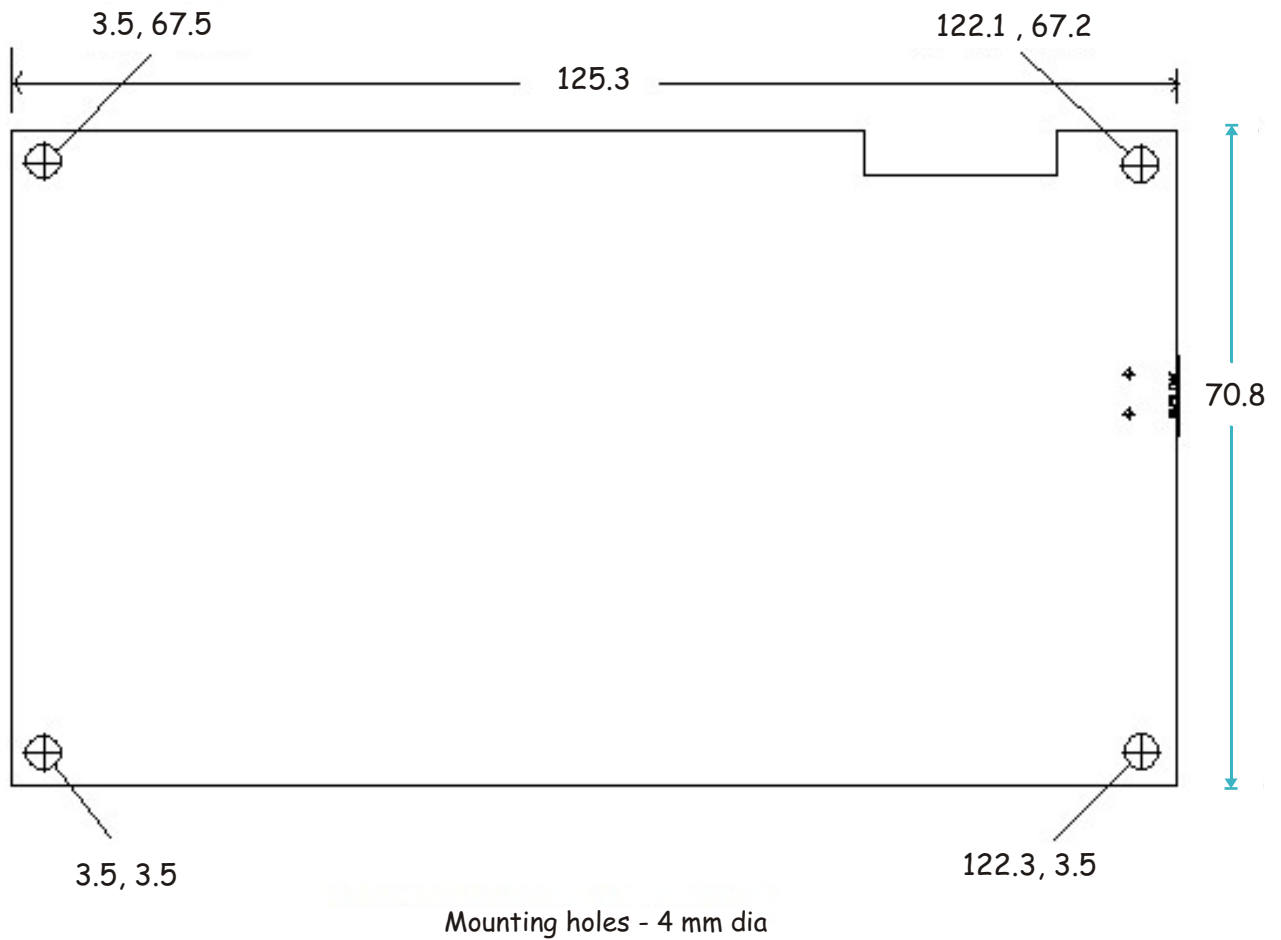

Please Read Carefully

Information in this document is provided solely in connection with Arnin Automatica products. Arnin Automatica Pvt Ltd. reserves the right to make changes, corrections, modifications or improvements, to this document, and the products and services described herein at anytime, without notice.

All Arnin Automatica products are sold pursuant to Arnin Automatica Pvt Ltd. terms and conditions of sale.

Purchasers are solely responsible for the choice, selection and use of the Arnin Automatica products and services described herein, And Arnin Automatica Pvt Ltd. assumes no liability whatsoever relating to the choice, selection or use of the Arnin Automatica products and services described herein.

No license, express or implied, by estoppel or otherwise, to any intellectual property rights is granted under this document. If any part of this document refers to any third party products or services it shall not be deemed a license grant by Arnin Automatica Pvt. Ltd for the use of such third party products or services, or any intellectual property contained therein or considered as a warranty covering the use in any manner whatsoever of such third party products or services or any intellectual property contained therein.

UNLESS OTHERWISE SET FORTH IN Arnin Automatica Pvt Ltd'S TERMS AND CONDITIONS OF SALE Arnin Automatica Pvt Ltd DISCLAIMS ANY EXPRESS OR IMPLIED WARRANTY WITH RESPECT TO THE USE AND/OR SALE OF Arnin Automatica PRODUCTS INCLUDING WITHOUT LIMITATION IMPLIED WARRANTIES OF MERCHANTABILITY, FITNESS FOR A PARTICULAR PURPOSE (AND THEIR EQUIVALENTS UNDER THE LAWS OF ANY JURISDICTION), OR INFRINGEMENT OF ANY PATENT, COPYRIGHT OR OTHER INTELLECTUAL PROPERTY RIGHT.

UNLESS EXPRESSLY APPROVED IN WRITING Arnin Automatica PRODUCTS ARE NOT RECOMMENDED, AUTHORIZED OR WARRANTED FOR USE IN MILITARY, AIR CRAFT, SPACE, LIFE SAVING, OR LIFE SUSTAINING APPLICATIONS, NOR IN PRODUCTS OR SYSTEMS WHERE FAILURE OR MALFUNCTION MAY RESULT IN PERSONAL INJURY, DEATH, OR SEVERE PROPERTY OR ENVIRONMENTAL DAMAGE.

Resale of Arnin Automatica products with provisions different from the statements and/or technical features set forth in this document shall immediately void any warranty granted by Arnin Automatica Pvt Ltd for the Arnin Automatica product or service described herein and shall not create or extend in any manner whatsoever, any liability of Arnin Automatica Pvt Ltd.

Manufactured by -

Arnin Automatica Pvt. Ltd
H.No.88, Akshay Colony,
Phae-1, Gokul Road,
Hubli - 580030, Karnataka.
India.

Contacts -

Web - arnin.in
Sales - sales@arnin.in
Support - support@arnin.in
Information - info@arnin.in

Buy online at our Shop - arnin.in